

Precast Concrete Smart Deck System for Sustainable Bridge Construction in Saudi Arabia

Ayed E. H. Alluqmani^{1*} and A. B. M. Saiful Islam²

¹Department of Civil Engineering, Islamic University in Madinah, Madinah: 41411, Saudi Arabia

²Department of Civil & Construction Engineering, College of Engineering, Imam Abdulrahman Bin Faisal University, 31451, Dammam, Saudi Arabia

* Corresponding author; E-mail: dr.ayed@iu.edu.sa

Abstract: Due to the increasing demand of infrastructures and transportation systems worldwide, recent development of bridge construction is in need of potential deck system. Kingdom of Saudi Arabia (KSA) is one of the developed countries seeking for the urban development, especially with the current Saudi's Vision-2030. Here, conventionally used bridge deck systems possess inferior strength/weight ratios; require a lengthy installation process; are susceptible to corrosion induced premature deterioration particularly in humid environments; and need extensive maintenance. Besides, precast prestressed concrete panels deck forms topped over by cast-in-place (CIP) concrete deck for an economic alternative bridge system due to their shop-made superior quality and time saving benefits. This study summarizes the recent development on modern bridge deck systems including its potential application in Saudi Arabia. The major findings and recommendations derived from experimental work and computer-aided analysis by diverse researchers are given. Finally, the current research presents the concept of Saudi Smart Deck System (SSDS), which is a precast waffle deck slab system, topped over by Ultra High Performance Concrete (UHPC). This will incorporate advanced cementitious materials (ACM), advanced design methods (ADM), structural health monitoring (SHM) and accelerated bridge construction (ABC). The precast waffle web will house the reinforcing steel thereby reducing the weight of the deck, whereas the UHPC topping will give the highest compressive strength for the deck concrete. The precast bridge deck systems mostly meet the requirements for strength and serviceability to use as an alternative for both new and old bridges. The proposed lightweight deck will be highly cost-effective as work-time will be significantly diminished, the life-time of construction/structure will be sustained; and it will be with lower maintenance costs. Such newly introduced smart deck system using eco-friendly construction material is intended to break price barriers in all markets and draw attraction of incorporating advanced bridge construction in Saudi Arabia and GCC countries.

KEYWORDS: Lightweight Concrete; Precast/Prestressed Concrete; UHPC; Bridges; PCP Panels; Saudi Smart-Deck; Waffle Deck Slab.

1. INTRODUCTION:

Precast concrete bridge deck panels are gaining popularity due to their speed of production, reduced labor requirements in the site and reduced traffic intrusion. The use of precast bridge decking grew abruptly all over the world (Xia *et al.*, 2019; Zafar *et al.*, 2020). Some studies proposed precast bridge decks using ultra-high performance concrete (UHPC) incorporating high

strength steel (HSS) (Saleem *et al.*, 2011); UHPC with fiber-reinforced polymers (Al-Ramahee *et al.*, 2017); UHPC together with carbon fiber reinforced polymer (CFRP) (Ghasemi *et al.*, 2016a). The UHPC offers good flowability, high crack resistance, very low permeability, and minimal shrinkage/creep qualities compared to conventional concrete. Aaleti *et al.* (2011) investigated the structural Behavior of Waffle bridge deck and the connections of precast UHPC. Saleem *et al.* (2011) used UHPC with HSS in asymmetric waffle deck structure having self-weight was 1.55 kN/m² which Ghasemi *et al.* (2016a) improved to 1.0 kN/m². Their capability as a bridge deck replacement were proved for both fixed and mobile bridges by static and dynamic testing. Ghasemi *et al.* (2016b) developed waffle bridge deck panels by combining UHPC with CFRP rebars. The goal was to balance the brittleness of CFRP with the ductility of UHPC and the panels meet the strength and serviceability standard with a stringer spacing of 1.2 m and just 102 mm total depth offering a self-weight of 0.9 kN/m². Precast deck panels of Al-Ramahee *et al.* (2017) using UHPC and FRP laminates with 127 mm overall depth and 0.5–0.6 kN/m² self-weight satisfied the restrictions of strength and serviceability.

Venancio (2016) evaluated half-scale partial-depth precast deck panels made from UHPC. Ground granulated blast furnace slag was utilized replacing quartz powder and a fraction of the fine sand (GGBS). The depths of the panels were 51 and 76 mm. The highest ultimate load was reached by UHPC with ordinary mild-steel reinforcement. Panels made of UHPC that were evaluated in a shear configuration failed in a flexure test as well, exhibiting outstanding shear force performance. Adding coarse aggregates to UHPC material is another technique to improve its long-term viability. Coarse aggregates were used in a variety of concretes for improving the cementitious products' financial and technical benefits (Duarte *et al.*, 2020) and their long-term viability has been established. (Tam *et al.*, 2015). Another feature of precast deck panels that may offer greater service is design optimization. Prestressing is one method for accomplishing this. Prestressing with high-strength or fiber reinforced concrete offers sizable potential in constructing bridge deck as it not only reduces the self-weight by reducing thickness, but it also has fewer maintenance requirements, increased longevity, narrower cracks, and high tensile strength. Several experimental and analytical studies were undertaken at University of Nebraska-Lincoln to determine their novel precast concrete deck's structural performance and constructability (Morcous *et al.*, 2018). It was presented that the approach enhanced the deck durability and improved its economic competitive with CIP concrete decks.

Al-Rousan (2020) showed the characteristics of full-depth precast concrete (FDPC) bridge deck with optimal prestressing. Akhnoukh (2020) introduced accelerated bridge construction strategy incorporating high performance concrete. Arezoomand Langarudi and Ebrahimnejad (2020)

carried out a computational investigation of the bolted shear connections' behavior in composite slabs with a steel deck. Song et al. (2021) evaluated fatigue performance of GFRP-concrete composite decks. Di *et al.* (2020) inquired the characteristics of U-bar joints in precast bridge decks imposed by bending and shear together. Moslemi et al. (2020) proposed a composite profiled sheet deck checked with finite element (FE) analysis. The behavior of continuous GFRP-concrete decks with steel bars was assessed by Tong *et al.* (2020)". Fu *et al.* (2020) investigated the behavior of adhesively attached engineered wood-wood chip concrete composite decks using an experimental and analytical approach. Numerical analysis of a heterogeneous concrete composite bridge deck was performed by Hájek et al. (2020) to a near field explosion. Shahrokhinasab and Garber (2021) evaluated the capability of FDPC deck panels over a lengthy period of time. Su *et al.* (2021) evaluated the effectiveness of patching material for concrete bridge decks. Yuen et al. (2020) provided a DFEM analysis of a prestress-changed post-tensioned precast concrete segmental bridge (PCSB) incorporating unbonded exterior tendons. Abo El-Khier and Morcous (2021) presented precast concrete deck-to-girder connection employing UHPC shear pockets. Saleem et al. (2021) discussed the recent advancements of prefabricated bridge deck systems. The prefabricated bridge deck systems developed utilizing a variety of materials, were shown to meet most strength and serviceability requirements having the potential to supplant traditional bridge deck.

However, the precast prestressed bridge deck system with UHPC is still a quite new concept in Saudi Arabia. Only a small amount of research has been done on the use of prestressing in conjunction with the use of long-lasting high performance reinforced concrete to construct bridge decks. Especially the waffle slab system combined with UHPC for precast bridge deck is rarely implemented. With this background in mind, the target of this study is to introduce an innovative precast concrete waffle slab deck system named as 'Saudi Smart Deck' for the advance bridge construction in the kingdom. The configurations composed of precast sustainable ultra-high performance concrete (sUHPC) bridge deck panels. This employs advanced cementitious materials (ACM), advanced design methods (ADM), structural health monitoring (SHM), and accelerated bridge construction (ABC). The precast waffle web houses the reinforcing steel leading to reduction of the weight of the deck, whereas the UHPC offers the highest compressive strength for the deck concrete providing lightweight behavior.

2. ADVANCEMENT OF PRECAST CONCRETE DECK SYSTEMS:

Precast/prestressed concrete-panels and their uses were first proposed in the early 1950s for a series of underpasses for the Illinois Toll Highway Authority on the Northwest Tollway near

Chicago (Barker, 1975; Goldberg *et al.*, 1987). That partial depth PCP - precast prestressed concrete panels deck forms. It was topped over by cast-in-place (CIP) concrete for an economic alternative bridge system. Since then, numerous bridges are built and replaced around the world, due to their shop-made superior quality and time saving benefits. They used different systems of precast and prestressed deck panels including *full-depth* panels and *partial-depth* panels. Prestressed concrete appeared as the best option and developed a design for prestressed SIP panels. The first such full-scale prototype bridge was load tested in Illinois, USA, started on May 21, and completed on July 8, 1956 which is sketched in Figure 1.

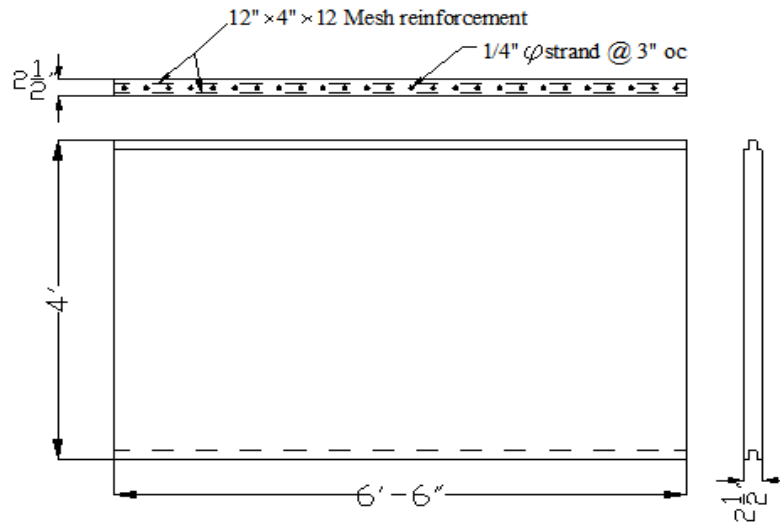

Figure 1: Sketch of Illinois Precast Concrete Panel.

2.1 Precast Prestressed Full Depth (PCP-FD) Deck:

An early example of the use of PCP-FD Precast, prestressed as full depth deck is in the “Pintala Creek Bridge” in Alabama in the 1960s (Moore *et al.*, 1992). Later this method was extended in 1990’s for Maryland’s rural highways (Narer, 1997). In 1982, PCI Bridge Committee Survey of the State Highway Departments showed that twenty one states used the panels regularly, while the remaining seven states chose the strategy through competitive bidding or were establishing details prior to trial projects (Goldberg *et al.*, 1987). Also in 1982, Bieschke and Klingner, University of Texas at Austin, tested full-scale bridge specimens and indicated that there was no difference in performance between decks constructed with or without strand extensions on a local or global scale (Bieschke and Klingner, 1982).

2.2 Precast Prestressed Partial Depth (PCP-PD) Deck:

In the 1990s, University of Nebraska-Lincoln researchers developed a precast/prestressed partial depth panels named NUDECK (Badie *et al.*, 1998). In 1996, Kumar and Ramirez (1996) examined the horizontal shear strength of the contact between composite decking and partial depth precast concrete panels. The prestressed decks with a broom-finished surface didn't need horizontal shear connectors when the normal horizontal shear stress experiences lower value than 116 psi (0.8 MPa). In 1997, Precast/Prestressed Concrete Institute (PCI) published 1st edition of "PCI Bridge Design Manual". This manual details PCP-PD and PCP-FD options including design, fabrication and construction (PCI, 1997). Strand extensions have a substantial cost impact since they need the fabrication to make forms in the bed in the middle of each panel. If no strand extension is available, the panels may be cast as one continuous slab and then cut to length once the concrete has reached transfer length and so strand extensions are generally not recommended (PCI, 2014).

2.3 PFRC Prestressed Bridge Deck:

Braimah *et al.* (1998) investigated a quarter-scaled transversely prestressed polypropylene fiber reinforced concrete (PFRC) deck panel using CFRP tendons, which was 6.09 x 1.63 x 0.043 m in length and supported by steel girders. The deck was prestressed transverse to the traffic direction. The results indicated that a 20% drop in depth from the code's minimum requirement still encounters the criteria of load and deflection. All slabs failed in punching shear when subjected to loads much more than the specified service load. The minimum capacity/demand ratio for punching shears was 6.8.

2.4 Prefabricated Bridge Deck with Prestressed HSFRC and UHPC:

Zafar *et al.* (2020) dealt with the characterization of precast bridge decks comprised of six full-depth prestressed high strength fiber-reinforced concrete (HSFRC) panels and six partial-depth UHPC composite bridge deck panels. The UHPC used ground granulated blast furnace slag (GGBS) in place of 30% of the cement and recycled aggregate concrete made using recycled aggregates replacing coarse aggregates up to 30%. Both systems had the potential as a viable alternative to traditional deck panels.

2.5 GFRP Prestressed Deck:

Wu (2003) conducted flexure, compression and fatigue tests on twenty-two GFRP prestressed deck specimens that had been transversely post-tensioned at the supports as well as mid-span to create a prestressing moment parallel to the traffic direction (Figure 2). In single and double span

designs, square tubes with varying span lengths were used. Short spans were more vulnerable to fatigue failure and broke in local shear but didn't require panel intervention. Longer spans were unable to bend. The FE analysis agreed with the experimental results.

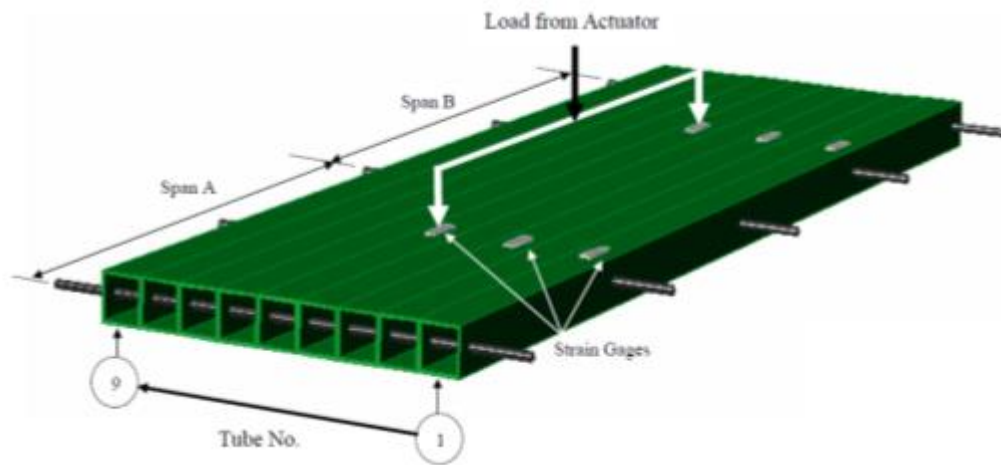

Figure 2: GFRP Prestressed Bridge Deck.

Due to the prestressing, residual strength is provided by this deck that may serve as a safety element when subjected to vehicular traffic. At large, the deck system is suitable to use in medium stringer spacings with a maximum operating load of 30 tons. However, this technique produces insufficient panel action as a result of tube slippage leading to cracking of the asphalt surface subjected to traffic loading. Increased panel action may be achieved through epoxy bonding or by prestressing level enhancement. Also, this deck panel significantly flounders under fatigue for shorter durations, which warrants additional examination.

2.6 Hybrid Precast Prestressed Bridge Deck:

Yang *et al.* (2012) investigated static and fatigue loads on twelve $2.440 \times 2.440 \times 0.075$ m precast-prestressed concrete deck panels. Except for the edge tendons, prestressing was done with 21 steel tendons. Six samples were constructed using traditional concrete (2 control + 4 hybrid) and the remaining samples comprised polypropylene fiber reinforced concrete (FRC). The hybrid panels exhibit consistent softening after 2 million fatigue cycles and CFRP had no effect on optimizing ultimate state response. The CFRP hybrid panels behaved identically to control panels in terms of cracking behavior and ultimate loads; however, addition of fibers enhanced ultimate load, stiffness, and displacement.

2.7 Precast Prestressed Bridge Collinear Deck:

Kwon *et al.* (2014) developed pre-cast bridge deck panels with narrower cracks that are more durable (Figure 3). The primary objective is to prevent collinear cracking in PCPs used in deck

panels. By reducing the initial prestress, as proposed above, the possibility of collinear panel cracking can be minimized without endangering the panel's strength or serviceability (Figure 4). Reduced initial prestress force and the lump-sum losses employed in design might meet up the requirements. The resulting cost and time reductions are significant, especially given the extensive usage of PCP construction in Texas as well as other states.

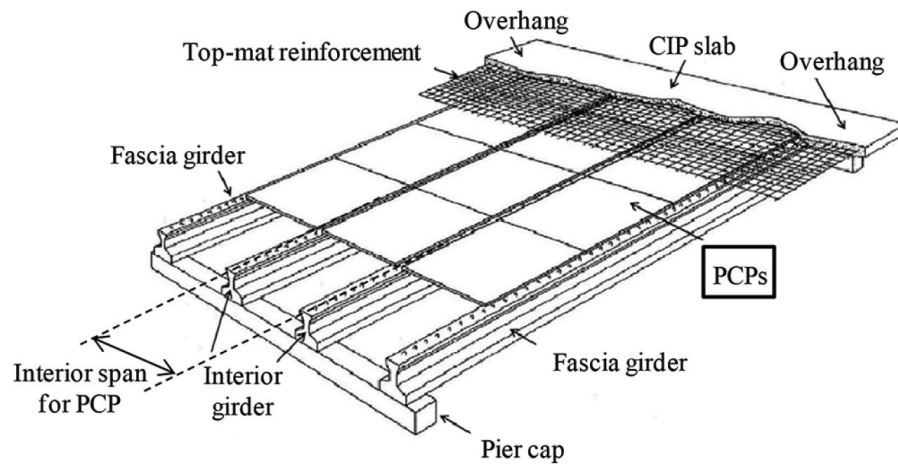

Figure 3: CIP -PCP Bridge Deck System (Kwon *et al.*, 2014).

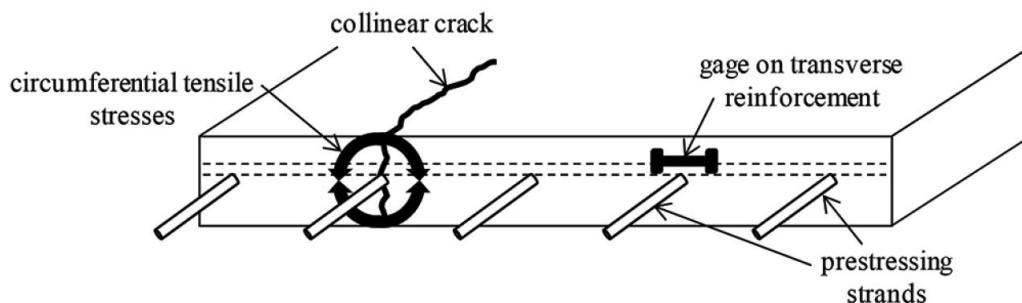

Figure 4: Collinear Cracking in PCP (Kwon *et al.*, 2014).

2.8 Precast Half Scale Partial Depth Bridge Deck:

Venancio (2016) assessed half-scale partial-depth precast bridge decks using UHPC where GGBS substituted quartz powder and a portion of the fine sand content. In the 51 and 76 mm deep panels, the inclusion of mild-steel offered maximum ultimate load. Despite their superior shear force capability, the UHPC panels also saw flexural failure.

2.9 Precast High-Performance Modular Deck:

Al-Ramahee *et al.* (2017) produced precast deck using UHPC and FRP laminates. There was no reinforcing using rebars. The 127 mm deep and 0.5–0.6 kN/m² self-weighted system satisfied the requirements of strength and serviceability. Such high-performance modular deck panels are advantageous for mobile bridges and deck repair or replacement. Seven single-unit deck specimens with spans of 1,220 and 864 mm met the target strength demand prior to failure due to top UHPC plate delamination from the core. Experimental data and associated FE models proved the constraint of load-transfer process by UHPC plate crushing and the interfacial bond with the core.

2.10 Precast Concrete Full Depth – Full Width (FD-FW) Deck:

The Nebraska Department of Roads (NDOR) and the University of Nebraska-Lincoln (UNL) recently developed an innovative precast concrete deck technology. Numerous analytical and laboratory investigations were undertaken at UNL to determine the structural performance of the system and its constructability (Morcous *et al.*, 2018). This approach eliminates the disadvantages of previous systems, including the high panel numbers, joints, and apertures; the complexity of panel production and assembly; the requirement for an overlay; and the difficulties of grouting and post-tensioning procedures. To decrease the number of panels and joints, the developed deck system (Figure 5) utilizes 12 ft (3.6 m) long full depth and full-width (FW) precast concrete panels. Each girder line of the panel has four covered pockets with a spacing of four feet (1.2 meters) for shear connectors to reduce penetrations into the deck surface and avoid the deck overlay requirement. Pre-tensioning and post-tensioning in the transverse and longitudinal direction respectively eliminates the operations of duct installation and grouting. Such unique properties increase the deck's endurance and cost competitiveness as compared to CIP concrete decks.

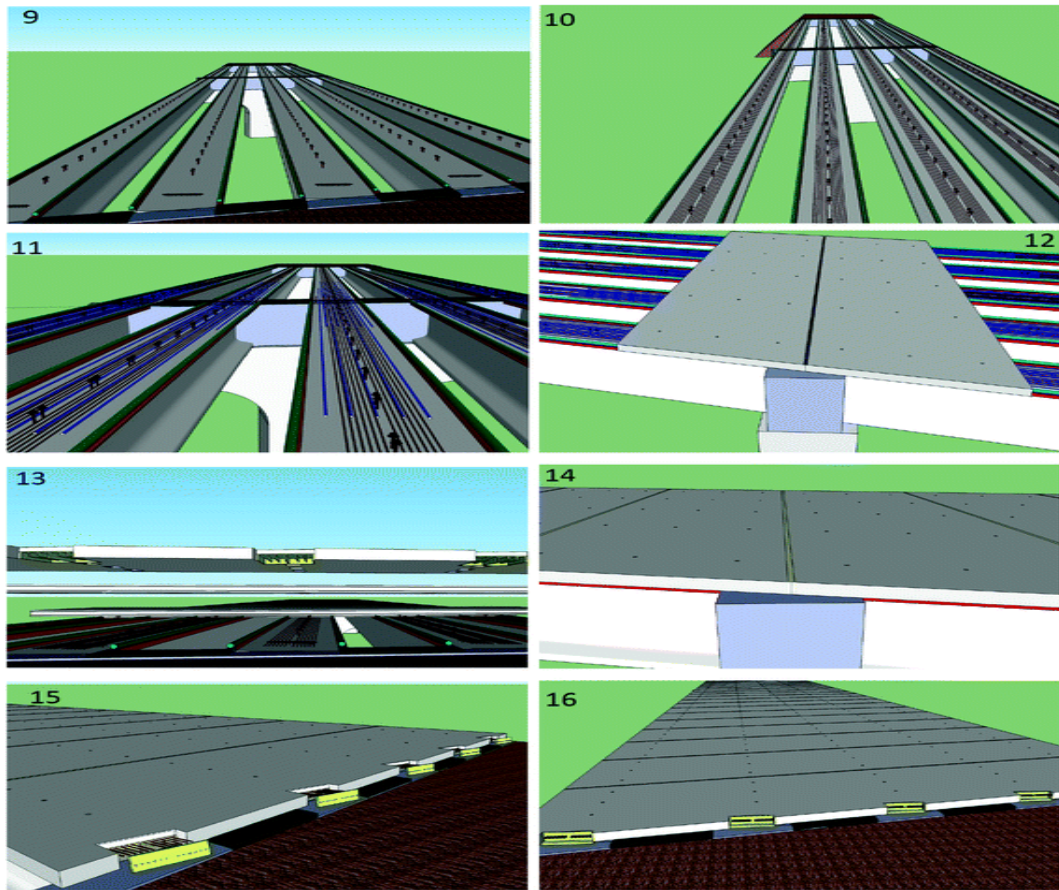

Figure 5: Construction Sequence of Full Depth - Full Width Precast Deck (Morcous *et al.*, 2018).

2.11 Precast Optimum Prestressed Full-Depth Bridge Deck:

Al-Rousan (2020) demonstrated the characteristics of an optimally prestressed FD precast concrete deck panel. Nonlinear FE analysis results matched the experimental data from the prototype bridge system's full-scale testing. The panel was accomplished to withstand and maintain its integrity even subjected to eight times of simulated AASHTO truck service loading confirming no significant reduction of ultimate strength capacity or stiffness. The bond stresses induced by live load for four lines prestress level were nearly 0.74 times of six lines prestress level's bond stresses.

2.12 Post-Tensioned - Precast Concrete Segmental Bridges (PT-PCSB) Deck:

Yuen et al. (2020) proposed a three-dimensional discrete finite element model (DFEM) of a prestress-changing post-tensioned PCSB with unbonded exterior tendons. A 20% increase/reduction in prestressing result in a 10% rise/16.8% drop in moment resistance but a 30.2% decline/36.6% growth in deflection capacity. For high prestressing level, 0.874 fpu, substantial concrete crushing occurs in bridge bottom area at ULS, limiting joint opening, development of tendon strain, and ductility. Instead, at low prestressing level, 0.125 fpu, the deck

decompresses even in self weight and becomes exceedingly unstable under extra load offering extremely low ductility and moment resistance. Additionally, at 0.6 fpu constant prestress level, tendons' stress change from effective prestress to ULS stress is consistent with the guidelines.

2.13 Full-Depth Precast Concrete (FDPC) Bridge Deck:

Shahrokhinasab and Garber (2021) assessed the durability of full-depth precast concrete (FDPC) deck panels. The performance of bridges was determined using simple linear regression and a deep learning model supplied by Long-Term Bridge Performance (LTBP). The type of joint, the category of traffic impact, the climate zone, the type of wearing surface, and the volume of traffic all had an effect on the behavior of bridges with FDPC deck panels. The type of construction (new versus renovation) had no effect on how these bridges behaved.

2.14 UHPC-HSS Deck:

Saleem *et al.* (2010) evaluated ribbed UHPC deck with HSS reinforcing bars. The 127 mm longitudinally deep and 76 mm transversely deep ribs including the 32 mm UHPC top plate were reinforced in both directions to transfer stresses transversely and to the steel girders. Shear failure of the panels occurred in a semi-brittle manner, and shear fractures emerged at a lower load than the case of flexural cracks. Multi-unit two-span specimens demonstrated a high rate of shear failure, but end-hook reinforcement was found to be useful to prevent failure of bond. With a capacity/demand ratio of around 2, a multi-unit deck demonstrated punching failure across the load patch. Saleem *et al.* (2015) defined the behavior of a $1.443 \times 0.300 \times 0.127$ m HSS reinforced UHPC ribbed deck (Figure 6) and the load transfer mechanism between the system's various components in the second phase. The lateral distribution of loads was also investigated using multi-unit specimens. Two million cycles of fatigue testing revealed no degradation, with residual strength 47 percent greater than the necessary strength. Post-peak activity demonstrated ductility and an ability to forewarn of impending failure. Epoxy grouting was a successful method of preventing differential movement between neighboring deck panels.

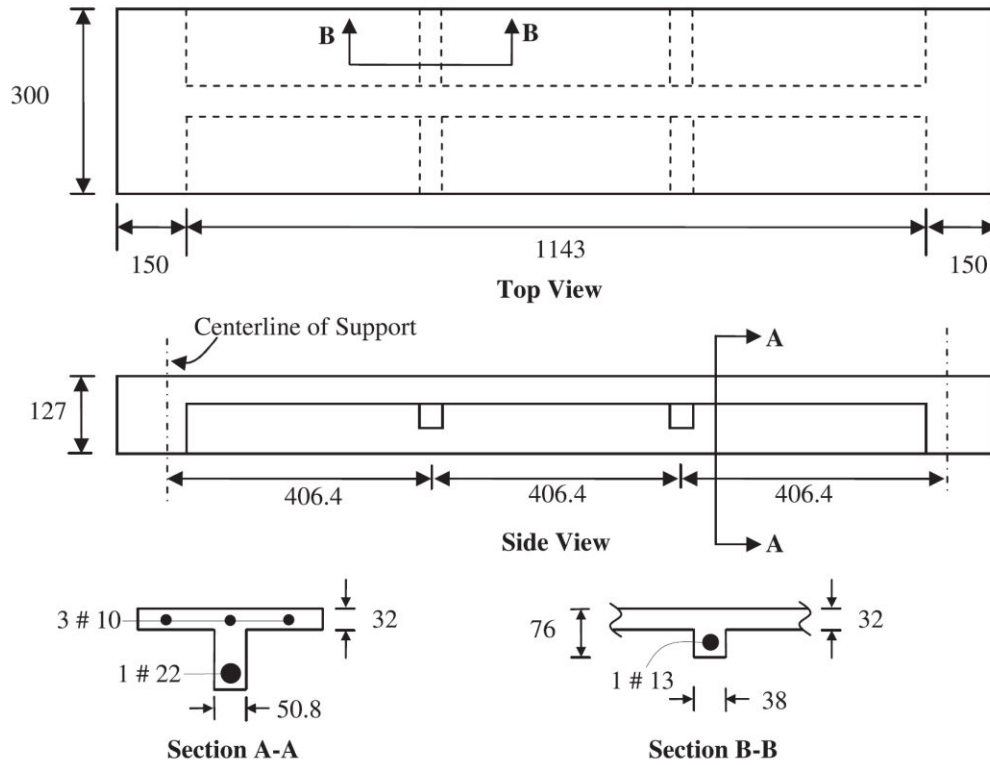

Figure 6: Sectional Views of Single-Unit Deck Panel (Saleem *et al.*, 2015).

2.15 UHPC-CFRP Mesh Deck:

Mirmiran *et al.* (2016) also used carbon fiber reinforced polymer (CFRP) grid mesh in in the UHPC slab, which was a change to the deck of Saleem *et al.* (2010) in order to further reduce self-weight. As an alternative to HSS bars, CFRP mesh was employed. The objective was to compensate for the brittle reaction of CFRP bars using UHPC's ductility. The capacity/demand ratio decreased from 4.4 to 1.7. The self-weight was lowered by 7.33 kg/m^2 , the deck exhibited three to four times higher deflection under service load than UHPC-HSS decks. The mode of failure remained ductile in spite of apparent shear failure. The system did not meet the criteria for serviceability.

2.16 UHPC-GFRP Corrugated Deck:

UHPC-GFRP hybrid deck was developed in the laboratory (Mirmiran *et al.*, 2016) using vacuum-assisted resin transfer molding (VARTM) infusion technology, which resulted in a 40% reduction in self-weight compared to the UHPC-HSS waffle slab. This system was constructed using bidirectional GFRP corrugations filled with foam and covered with unidirectional GFRP at the top and bottom, which was then covered with a UHPC wearing surface to absorb tension. No

compression or tension stresses were exceeded, and the failure occurred as a result of web buckling or a failure of the interface between the concrete and the FRP.

2.17 UHPC-GGBS Deck:

Venancio (2016) compared the performance of 12 half scale 1.22×0.91 m stay-in-place (SIP) form panels made of UHPC and GGBS to standard concrete panels in flexure and shear. The reinforcement was either non-existent/conventional or comprised of wire mesh. Deck panels with a thickness of 51 mm or 76 mm were evaluated in shear or flexure for all material types and reinforcement combinations. The ultimate load capacity of UHPC reinforced with mild steel was the highest, while 51mm UHPC reinforced with wire mesh had nearly the same capacity as 76mm control concrete panels reinforced with wire mesh. These wire mesh panels are incredibly simple to construct. Additionally, the shear-tested UHPC panels failed in flexure, indicating that they possess exceptional shear characteristics.

2.18 UHPC-HSS Waffle Deck:

Mirmiran et al. (2016) conducted a detailed investigation into the development of a lightweight solid deck for movable bridges. One type of system was a UHPC waffle deck reinforced in the stronger direction with HSS steel bars. This configuration was nearly identical to that studied by *Saleem et al.* (2010) with the exception that the capacity to demand ratio was optimized by increasing rib spacing and decreasing the deck thickness to 102 mm to reduce the system's weight. The capacity-to-demand ratio has been reduced to approximately 2.2 from approximately 4.4 previously. Additionally, the impact on continuity and panel action were examined. The system retains a reasonable degree of ductility despite shear failure. Weight savings of 37% were achieved when compared to the *Saleem et al.* (2010) deck. Due to the low concrete cover, meticulous quality control is necessary to avoid construction and performance issues.

2.19 FD-UHPC Waffle Bridge Deck:

Aaleti et al. (2011) conducted a full-depth investigation of the structural behavior of precast UHPC waffle deck panels. A full-scale, single-span, 60-ft long by 33-ft wide prototype bridge with full-depth prefabricated UHPC waffle deck panels has been designed as a replacement bridge in Wapello County, Iowa. The system was tested for service, fatigue, and ultimate loads using two prefabricated, full-depth UHPC waffle deck panels connected to two precast prestressed girders measuring 24 feet in length. The concept of a prefabricated UHPC waffle deck system was determined to be a feasible solution for meeting the objectives of the AASHTO strategic plan.

2.20 Asymmetric UHPC-HSS Waffle Bridge Deck:

A low-profile asymmetric waffle deck comprising UHPC and HSS was developed by Saleem *et al.* (2011). The deck's self-weight was 1.55 kN/m², which was improved 1.0 kN/m² by Ghasemi *et al.* (2016a). Static and dynamic testing established their feasibility and potential to use as a bridge deck replacement for both fixed and mobile bridges.

2.21 UHPC-CFRP Waffle Bridge Deck:

Ghasemi *et al.* (2016b) used UHPC and CFRP rebars to create waffle bridge decks. The objective was to strike a balance between the brittleness of CFRP and the ductility of UHPC. According to the study, the panels satisfy the criteria of strength and serviceability for 1.2 m stringer spacing while having an overall depth of 102 mm and a self-weight of 0.9 kN/m².

3. BRIDGE DECK SYSTEMS IN SAUDI ARABIA:

The *transportation* system of Saudi Arabia is well developed with conventional bridge system. Following are the highlights of some famous bridges along with their structural configurations.

3.1 Dammam Bridge:

For developing the area of Dammam, the governorate undertook a comprehensive program to upgrade the road infrastructure connecting Dammam and Khobar, Bahrain's twin cities. Among these improvements was the Dammam Bridge (Figure 7), a seaside flyover located at the confluence of the Coastal Road and the Port Road, a location that was perpetually gridlocked due to rail traffic from the port. The construction is comprised of four parallel viaducts that are meant to carry the majority of traffic arriving in both directions from the Coastal Road (North & South Major Bridges) and to allow access to the Port Road through the two nearby ramps.

The precasting technique utilized in this project was referred as "match-casting which utilizes the previously cast segment as a "mold" for subsequent castings, ensuring that the faces of two adjacent segments always form a precise match. This technology necessitates the employment of specialized formwork – precasting units – to prefabricate the bridge deck segment by segment while adhering to the required horizontal and vertical alignments. The project's 48 spans were comprised of 714 parts in total. To accommodate as many segments as feasible in a single unit and to eliminate the time-consuming procedure of transferring freshly-stripped segments between units, precast units were designed in a uniform manner.



Figure 7: Precast Dammam Bridge (Freysinet, 2022a).

3.2 Rail Over Precast Bridge:

The rail over precast bridge (Figure 8) is a pre-cast railway bridge with two 33-meter-long spans that serves as an overpass over a highway in Saudi Arabia. It is one of the bridges that connects Damam and Jubail with the new high-speed train. The bridge's unique features are – first and foremost – the significantly enhanced freight capacity of the commercial train and – secondly – the train's top speed of 250 kilometers per hour.

The longitudinal T-beams, which measure 33 meters in length and 2.5 meters in height, were fabricated as pre-cast reinforced concrete beams and then post-tensioned on-site before being installed in their final location. The beams were laid in a fairly short period of time using lifting equipment with a capacity of 200 tons. The longitudinal and transverse arrangement of the elastic bearings is also particularly important since it allows for strict displacement limitations under the following sorts of loads: temperature, train braking and setting out, wind, and earthquake. The slab for the deck and the transverse beams were cast in place.



Figure 8: Rail Over Precast Bridge (Kanellopoulos, 2019).

3.3 Manifa / Safaniyah / Tanajib / Nariyah Bridge:

The construction of widely famous four concrete bridges comprises 26.60m-width x 62.80m-length Manifa (Figure 9), Safaniyah and Tanajib Bridges and 33.76m-width x 70.80m-length Nariyah Bridge. Reinforced concrete precast-post tensioned girders and concrete deck slabs were employed for the bridges during the construction process.



Figure 9: Manifa Bridge (Aramco, 2017).

3.4 Arch Bridge:

The Arch Bridge is a 560-meter-long railway bridge with 17 spans that acts as an overpass for a railway junction. It is part of the new 120-kilometer-long high-speed railway line between Dammam and Jubail in Saudi Arabia. It is made up of access bridges and the center bridge itself. The central bridge is comprised of three spans of 30, 80, and 30 meters in length. It is made of post-tensioned concrete and is formed as a continuous beam with an inverted, Π -shaped cross section. The cross-section of the 80-meter-long mid-span varies in height and forms an arch with a maximum radius of 9.50 meters in the middle (Figure 10). The cross-section shape aided in achieving the lowest possible elevation of the "red line" in the center span, hence reducing the length of the access bridges.

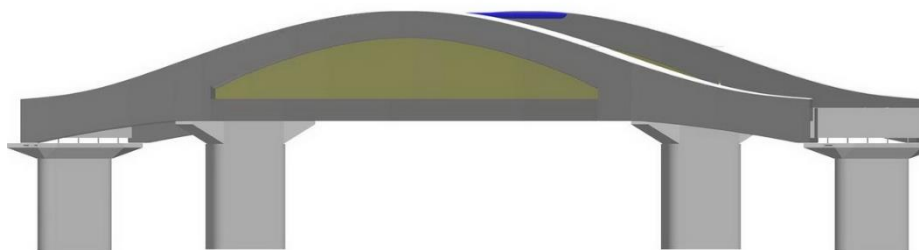

Figure 10: Arch Bridge (Kanellopoulos, 2019).

They are made of pre-cast post-tensioned reinforced concrete T-shaped beams that are "simply supported" at a height of 2.5 meters. Due to the trains' high traffic loads and fast speeds, the

bridges needed to be extremely strong to avoid vibration oscillations. The central bridge's construction process is quite straightforward, as it entails the building of scaffolds approximately 10 meters in height immediately on the ground. The deck slab is post-tensioned longitudinally and transversely in phases. The compression portion of the arch at the central bridge's mid-span is reinforced concrete. Pre-cast T-shaped beams are concreted in situ on the access bridges. After post-tensioning, these transverse beams are positioned in their final places on three-direction elastic bearings. The concreted-in-place deck slab joins the T-shaped beams above the piers and, as a result, the bridge spans, with an expansion joint every three spans.

3.5 Al-Jamarat Bridge:

The four-level segmental bridge (Figure 11) under construction is equipped with access ramps, service buildings, and helicopter towers to accommodate the high volume of pilgrims during the holy month of Hajj. Each level of the bridge is comprised of three ellipses and a passageway of 600m in length and spanning between 60 m and 100 m. Additionally, each level of the bridge deck is constructed using 1260 precast concrete segments weighing between 44 and 60 tons. FSA's scope of work comprises lifting and erecting precast segments utilizing specifically constructed mobile lifting equipment with a capacity of 70 tons, as well as all prestressing, horizontal jacking, and geometry modification operations.



Figure 11: Improvement of Al-Jamarat Bridge (Freysinet, 2022b).

From the structural considerations of mentioned bridges along with other existing bridges in the Kingdom of Saudi Arabia, the parameters and details for the bridge deck systems in Saudi Arabia are summarized in Table 1. The characteristics of design truck are illustrated in Figure 12.

Table 1: Bridge Deck Systems in Saudi Arabia.

Parameters	Values**
1. Thickness of the Bridge Deck.	180 mm – 250 mm (7.2 in – 10.0 in).
2. Concrete Compressive Strength (f_c), Bridge Deck.	35 MPa (5.0 ksi) at 28-days.
3. Steel Yield Strength (f_y) specified/assumed for the Bridge Deck.	Grade-60 - 420 MPa (60.0 ksi).
4. The “Total Number of Bridges” in the KSA (approximate).	4989 Bridges (2017 statistics, Ministry of Transportation, KSA).
5. Main Girder Types.	- RC Girders (T-Shape) - Prestressed/Precast RC Girders (I-Shape) - RC Girders (Box-Shape) - Steel Girders.
6. Average Spacing between Girders.	1.82 m – 2.0 m (6.0 ft – 6.65 ft).
7. Live Load for the Bridge Deck.	600-kN (60-Ton) 3-Axle Truck Loading. (133-K 3-Axle Truck Loading)
8. Spans of Bridge Girders.	12 m – 45 m (40.0 ft – 150 ft).
9. Age of Bridges under Repair/Maintenance.	> 45 Years
10. Most Types of Maintenance for Bridges.	1. Asphalt Layers, 2. Expansion Joints, 3. Girders and 4. Abutments.
11. Components of Bridges.	Deck Slab - Bridge Parapet - Approach Slab - Expansion Joints - Bearings - Girders - Abutments - Piers – Foundations.
12. Types of Bridge Components under Repair.	Abutments - Girders - Piers
13. Unit of Cost for Bridge Components.	Cubic meter (or ft ³) for RC and Precast.
14. Total Cost of Materials, Labors & consumptions to the Total Cost of Bridge Project.	75% – 80% ((Profit = 20% to 25%)).
15. % Cost of Materials, Labors and consumptions to the Total Cost of Bridge Project.	35% – 45% Materials ≥ 30% Labors ≥ 5% Consumptions
16. Diff. in % Cost of RC and Precast Components.	Precast Cost ≥ 10% RC Cost.
17. Days gap between placing Precast Girders and casting Deck Slab.	Deck Slab can be directly cast. (Time is only for shuttering, etc).

**Mentioned in the acknowledgement.

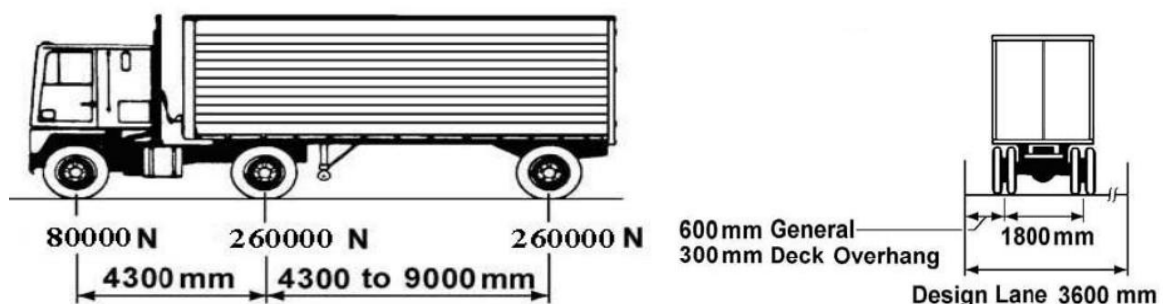

Figure 12: Characteristics of Design Truck-600-kN (60-Ton) 3-Axle Truck Loading.

4. PROPOSED SAUDI SMART DECK:

An effective precast prestressed concrete deck system named “*Saudi Smart-Deck*” is proposed here. This bridge precast concrete deck System will be made into two parts. Bottom will be a precast waffle slab 150 mm (6.0 in) thick, which will be topped by 50 mm (2.0 in) cast-in-place

high performance concrete (HPC). For deck panels, a minimum thickness of 175 mm (7.0 in) is being provided as per the requirement (AASHTO, 2012). Specific bridge geometry is used for the deck panels to determine their length and width. In the KSA, the center to center girder distance varies from 1.8 to 2.0 m (6.0 ft to 6.65 ft). The waffle slab width (short direction, perpendicular to traffic) can be between 1.1 m to 1.5 m (3.65 ft to 5.0 ft) and the length (parallel to traffic) could be 3.0 m to 4.0 m (10.0 ft to 13.35 ft). Figure 13 shows precast waffle slab 150 mm (6.0 in) thick., topped by 50 mm (2.0 in) CIP-HPC from top. This will ensure accelerated bridge construction (ABC) during the implementation phase.

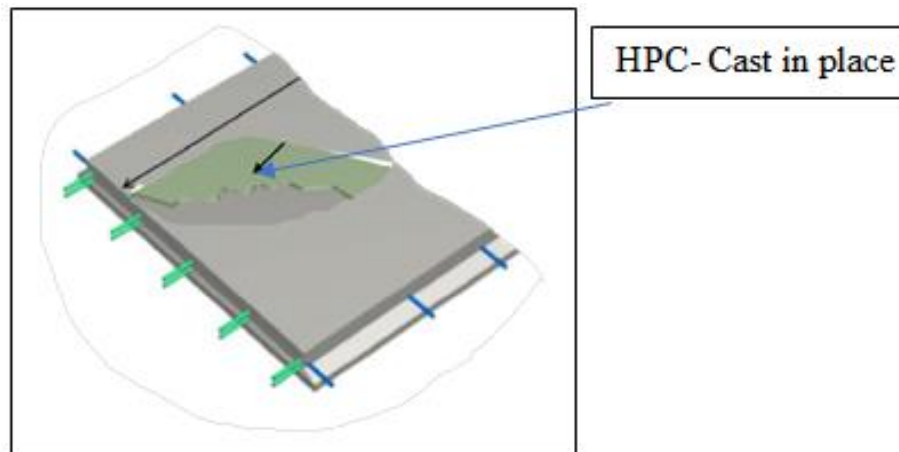

Figure 13: Precast Waffle Slab 150 mm (6 in) thick., topped by 50 mm (2 in) CIP-HPC from top.

Figure 14 illustrates a cross section of precast slab. Sectional views of precast waffle slab from bottom and top are shown in Figure 15.

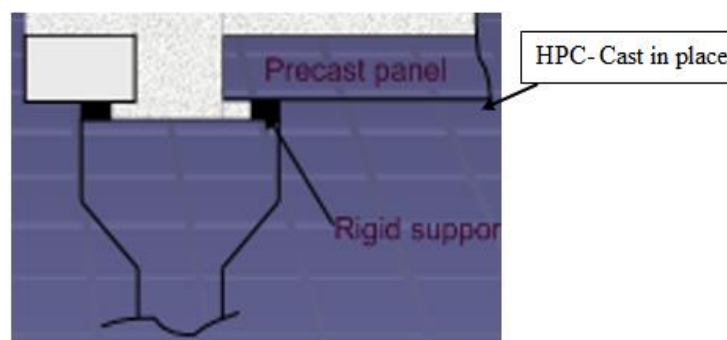
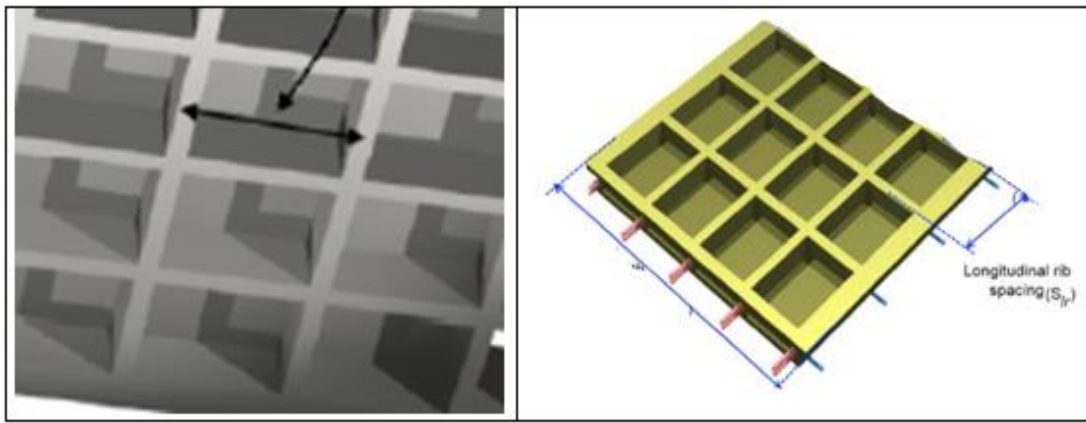
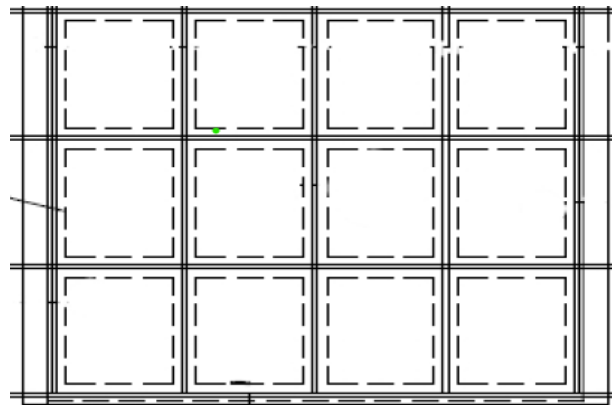

Figure 14: Cross Section of Precast Slab, Topped by CIP.



(a) Precast Waffle Slab from Bottom.



(b) Precast Waffle Slab from Top.

Figure 15: Precast Waffle Slab from Bottom and Top.

4.1. Ultra-High Performance Concrete (UHPC) Topping:

A compressive-strength equal to or more than 22 ksi (155 MPa) could be used for the Ultra-High Performance Concrete (UHPC) (Graybeal, 2006; Schmidt and Fehling, 2005). A form of UHPC with steel fibers can offer compressive strengths of 24 to 30 ksi (170 to 210 MPa). Such UHPC consists of Portland cement, sand or fine aggregate, super-plasticizers, steel-fibers, crushed-quartz, and high water reducers where the target strength is achievable in Saudi Arabia (Ahmad *et al.*, 2014). The advanced cementitious material (ACM), silica-fume is employed to ensure the enhanced strength. Using the lightweight concrete the density will be lower and using the cementitious material as well as steel fiber the concrete will achieve the UHPC properties.

4.2. Radio Frequency Identification (RFID) Sensors:

Radio Frequency Identification (RFID) sensors will be placed in the web of the deck and at the top slab to the structural health monitoring (SHM) for getting the continuous essential properties of quality assurance. The BAM (Germany) made RFID sensors will be used that are capable of measuring characteristics such as moisture content, temperature, and corrosion indicators and

transmitting them to the controller's hand-held reader or even the moving vehicle with the reader. It will not need any battery, so it will serve for lifetime.

4.3. Design of the System of Waffle Deck-Panel:

The strip-method is being used to design the *system of waffle deck-panel* which is described by the specifications of AASHTO-LRFD (AASHTO, 2012). The analysis of the deck can be carried on a transverse-strip as a continuous-beam supported by bridge-girders, where each girder can be considered as a rigid non-settling support. There are some factors affecting the determination of the width of transverse-strip, such as: the regions of the deck panel (along the panel length and across the panel width), positive-moment (M+ve), negative-moment (M-ve) or overhang. The transverse-strip width (W_{ts}) can be obtained in inch from the AASHTO-LRFD (2010) guidelines (Article 4.6.2.1.3) as shown below in Equation 1.

$$W_{ts} = \begin{bmatrix} 26 + 6.6S \\ 48 + 3.0S \\ 45 + 10.0X \end{bmatrix} \quad \text{(Equation 1)}$$

Where, S is the spacing between girders (in feet) and X is critical location distance (in feet) measured to the exterior-girder's centerline.

At different limit states, effects of both dead- and live- loads can be resisted with lod-factors by the design of entire transverse-strip. For different girder spacing (S), Table 2 presents the equivalent widths of transverse strip (W_{ts}) (Aaleti *et al.*, 2013). As discussed in Table 1, the distance between girders in the KSA varies from 1.82 to 2.0m (6.0 ft to 6.65 ft). For this proposed design, 1.82 meter (6.0 feet) is considered. Therefore, from Table 2 the transverse strip width of 6.0 ft span will be 65.6 (1640 mm) and 66.0 inches (1650 mm) for positive (+ve) and negative (-ve) moments respectively.

Table 2: Design of Transverse-Strip Width (W_{ts}) for Different Spacings between Girders.

Span (in.)	Transverse Strip Width (in)	
	For Positive Moment	For Negative Moment
48	52.40	60.00
51	54.05	60.75
54	55.70	61.50
57	57.35	62.25

60	59.00	63.00
63	60.65	63.75
66	62.30	64.50
69	63.95	65.25
72	65.60	66.00

The design positive-moment strength-I limit-state demand is 8.83 kip.ft/ft (12.0 kN.m/m) for transverse rib-spacing of 18.0 inches (450 mm) and girder-spacing of 6.0 ft. (1800 mm) as per the specification (Aaleti *et al.*, 2013). Moreover, for UHPC-waffle deck-panel, the design positive-moment strength-I limit-state demand is 7.83 kip.ft/ft (10.62 kN.m/m) for transverse rib-spacing of 18.0 inches (450 mm) and girder-spacing of 6.0 ft. (1800 mm).

The proposed Saudi Smart-Deck might be consisted of 50 mm (2.0 in)-UHPC CIP concrete with precast 140 mm (5.6 in) web and 25 mm (1.0 in) precast monolithic deck (Figure 16). The precast element of the deck consists of the web: 76 mm (3.0 in) wide at the bottom and 100 mm (4.0 in) wide at the top; with 25 mm (1.0 in) thick precast flange.

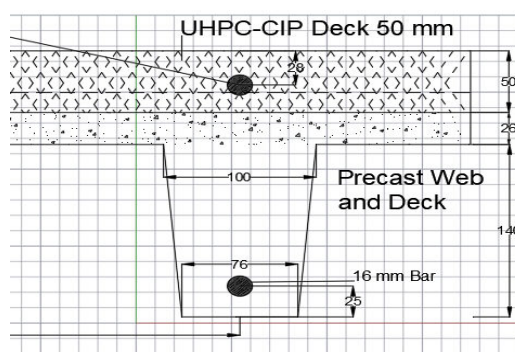

(a) Details of a Typical Rib.

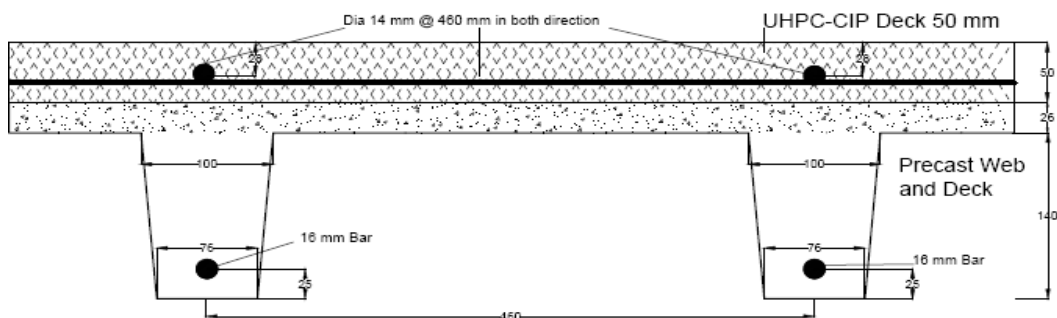

(b) Typical Panel Strip.

Figure 16: Typical Rib and Panel Strip in both Directions.

4.4. Numerical calculation of Deck Slab Strength Design:

As per the criteria discussed above, the design of a Concrete deck slab is being shown for width =65 inch (1625 mm) using the UHPC having $f_c' = 155 \text{ MPa}$ (22 ksi) and $f_y = 420 \text{ MPa}$ (60 ksi).

Consider: Bar size # 5 ($\Phi 16 \text{ mm}$): Bar spacing, $s = 65.0 \text{ in}$.

Bar diameter of $\Phi 16 \text{ mm}$ steel, $d_b = 0.625 \text{ in}$.

Bar area of $\Phi 16 \text{ mm}$ steel (equivalent to US #5), $A_b = 0.310 \text{ in}^2$ (201 mm²).

Area of steel per design strip,

$$A_s = b \cdot (A_b/s) = 12.0 \text{ in} \times (0.310 \text{ in} / 65.0 \text{ in}) = 0.05723 \text{ in}^2.$$

Equivalent stress block depth,

$$\begin{aligned} a &= A_s \cdot f_y / (0.85 \cdot f_c' \cdot b) \\ &= 0.05723 \times 60 \text{ ksi} / (0.85 \times 22 \text{ ksi} \times 12) \\ &= 0.0153 \text{ in} \quad [f_c' = 155 \text{ MPa} (22 \text{ ksi}) \text{ and } f_y = 420 \text{ MPa} (60 \text{ ksi})] \end{aligned}$$

For $f_c' = 28 \text{ MPa}$ (4 ksi): $a = 0.05723 \times 60 \text{ ksi} / (0.85 \times 4 \text{ ksi} \times 12) = 0.084 \text{ in}$

Effective depth of section,

$$\begin{aligned} d_s &= t_{\text{Deck}} - c_{\text{Bot}} - d_b/2 \\ &= 8.4 \text{ in} - 1.0 \text{ in} - 0.625\text{-in}/2 \\ &= 7.08\text{in}. \end{aligned}$$

Factored flexural resistance,

$$\begin{aligned} +\Phi \cdot M_n &= \Phi \cdot A_s \cdot f_y \cdot [d_s - (a/2)] \\ &= 0.9 \cdot 0.05723 \cdot 60 \text{ ksi} \cdot (7.08\text{in} - 0.084/2) \\ &= 21.75 \text{ k.ft}. \end{aligned}$$

The design positive moment, $+M_u$ strength-I limit state demand is 8.83 kip.ft/ft (12.0 kN.m/m (Aaleti *et al.*, 2013).

Check for $+\Phi \cdot M_n \geq +M_u$: $21.75 \text{ k.ft} > 8.83 \text{ k.ft}$, then ok.

Minimum reinforcement, $A_{s,\text{min.}} = 0.0018 \cdot b \cdot h = 0.0018 \times 18 \times 3 = 0.0972 \text{ in}^2$.

Consider the Bar size for minimum reinforcement as # 4

So $A_s = 0.2 \text{ in}^2$ in both directions $> A_{s,\text{min.}} = 0.0972 \text{ in}^2$, then ok.

4.5. Benefits of Using the Proposed Saudi Smart-Deck:

The proposed precast waffle UHPC deck system:

- increases the strength/resistance of the bridge's superstructure when composite actions are equipped by bonding through roughened precast panel top.
- enhances the rigidity/stiffness of the bridge's superstructure.
- improves the structural behavior of the bridge's superstructure.
- helps densely packed thin-particles to prevent the admittance of water which could then causes problems, while rendering the overlay weatherproof.

- helps to prevent cracking, spalling and scaling where steel fibers provide tensile resistance. This is even under heavy stresses from road traffic and deicing chemicals.
- is quick and simple to implement.
- is highly cost-effective: job-time will be diminished, the life-time of construction will be sustained, and maintenance costs will be low.
- offers improved construction quality.
- reduces impact on traveling public.
- ensures lower life-cycle cost.

4.6 Limitation of proposed Waffle UHPC deck system:

Though the waffle slab system in the proposed precast waffle UHPC deck system has significant benefits its noteworthy that the waffle slab has a few demerits as well. It

- is not widely used in conventional construction projects.
- requires special or proprietary formwork which is costly.
- needs rigorous supervision and skilled labor in construction.
- creates challenge to produce ultra-high performance concrete using lightweight aggregate
- makes difficulty in maintenance
- is not suitable in highly windy area
- is expensive, so it is only economical when large scale production of similar units is desired.

4.7 Fire resistance of Waffle slab in the proposed deck system

The fire tests (Fanella et al., 2017) demonstrated that the concrete cover to the reinforcing bars on the fire side is the controlling parameter for determining the fire resistance of concrete waffle slab systems. It was discovered that the voids function as a thermal insulator, as the heat from the fire is contained beneath the void. This causes the reinforcing bars located beneath the voids to experience slightly higher temperatures. The internal temperature remained between 200 and 300 degrees Fahrenheit below the melting point. A cover of three-quarters of an inch over the primary flexural reinforcing bars resulted in a fire resistance rating of at least two hours, as confirmed by finite element analyses (Fanella et al., 2017). This meets the minimum fire-resistance requirements for floor assemblies in shared spaces. After the fire tests, the integrity of the void formers was confirmed. These reinforced concrete floor systems are naturally resistant to fire, so no additional costly fireproofing is required to meet required fire ratings.

By overcoming the constraints, the proposed precast bridge deck systems largely meet the requirements for strength and serviceability to use as an alternative for both new and old bridges. Such lightweight deck will be highly cost-effective as duration of construction will be significantly diminished, the life-time of construction/structure will be sustained; and it will be with lower maintenance costs.

The UHPC construction material is composed of locally available waste material which is treated as aggregate. This will preserve the environment, assist the living social habitat as well reduce the construction cost. Moreover, the advanced cementitious material will increase the strength significantly which is also a bi-product of industry requiring no cost. This makes the material sustainable and ultimately the cost effective and environment friendly solution offers the construction as a smart and sustainable precast bridge system.

5. CONCLUSIONS:

Following conclusions have been drawn from the meticulous study:

- The advancement of the precast concrete bridge deck system has been overviewed in the study involving its implementation in Arab region.
- Results and recommendations based on experiments and computer-aided analysis by a wide range of researchers have been provided. Lastly, the Saudi Smart Deck System (SSDS), a precast waffle deck slab system topped with Ultra High Performance Concrete (UHPC), is presented in this study (UHPC).
- UHPC topping will provide the highest compressive strength for the deck concrete, while precast waffle webs will reduce the deck's weight. Both new and old bridges can benefit from precast bridge deck systems that meet most of the structural and serviceability requirements.
- There are numerous advantages to the proposed lightweight deck, including reduced construction time, a longer-lasting structure, and lower maintenance costs.
- The concept of Saudi Smart-Deck is a precast waffle deck slab system topped over by Ultra High Performance Concrete (UHPC) is certainly viable and cost effective for Saudi Arabia. The existing design of the bridges need not to change at all levels, rather only the cast in place deck slab will be updated with this new design.
- The deck will be highly cost-effective as job-time will be significantly diminished, the life-time of construction/structure will be sustained for long time; and it will be with lower maintenance costs. The precast web and deck will ensure top quality and the UHPC topping will ensure that the top surface is damage free and infiltration resistant to any

liquid. The Deck will also hold smart sensors that can monitor structural health and also track traffic information.

- In bridge construction, such precast concrete deck systems are expected to increase construction quality, minimize construction time and impact on the traveling public, provide lightweight construction, and cut life-cycle costs.
- Eco-friendly construction materials used in this new smart deck system are intended to break down price barriers in all markets and attract interest in incorporating advanced bridge construction in Saudi Arabia and the GCC countries.

6. ACKNOWLEDGEMENT:

The author thanks all associated personnel who contributed to this study, and acknowledges the information provided by Engr. Fahd Alsaedi (Director of Projects Department, Ministry of Transportation, Madinah, KSA), Engr. Maher M. Haylam (Bridge Maintenance Engineer, Shibh Al-Jazeera Contracting Company, Madinah, KSA) and Engr. Nasr Sakr (Implementation and Supervision Engineer, Euro-Group for Engineering Consultancy, Madinah, KSA).

7. REFERENCES:

- Aaleti, S., Petersen, B. and Sritharan, S. (2013). *Design guide for precast UHPC waffle deck panel system, including connections*: Federal Highway Administration, United States.
- Aaleti, S. R., Sritharan, S., Bierwagen, D. and Wipf, T. J. (2011), "Structural Behavior of Waffle Bridge Deck Panels and Connections of Precast Ultra-High-Performance Concrete", *Transportation Research Record: Journal of the Transportation Research Board*, **2251**(1), 82-92. doi:10.3141/2251-09
- AASHTO. (2012). AASHTO LRFD bridge design specifications: Customary US units 2012: AASHTO Washington, DC.
- Abo El-Khier, M. and Morcou, G. (2021), "Precast concrete deck-to-girder connection using Ultra-High Performance Concrete (UHPC) shear pockets", *Engineering Structures*, **248**, 113082. doi:<https://doi.org/10.1016/j.engstruct.2021.113082>
- Ahmad, S., Hakeem, I. and Maslehuddin, M. (2014), "Development of UHPC Mixtures Utilizing Natural and Industrial Waste Materials as Partial Replacements of Silica Fume and Sand", *The Scientific World Journal*, **2014**, 713531. doi:10.1155/2014/713531
- Akhnouk, A. K. (2020), "Accelerated bridge construction projects using high performance concrete", *Case Studies in Construction Materials*, **12**, e00313. doi:<https://doi.org/10.1016/j.cscm.2019.e00313>
- Al-Ramahee, M. A., Chan, T., Mackie, K. R., Ghasemi, S. and Mirmiran, A. (2017), "Lightweight UHPC-FRP composite deck system", *Journal of Bridge Engineering*, **22**(7), 04017022.
- Al-Rousan, R. (2020), "Behavior of Prefabricated Full-Depth Precast Concrete Bridge Deck Panel System: Optimum Prestress Level", *Procedia Manufacturing*, **44**, 607-614. doi:<https://doi.org/10.1016/j.promfg.2020.02.249>
- Aramco. (2017). Manifa Highway Bridges (4Nr). Manifa, Saudi Arabia.
- Arezoomand Langarudi, P. and Ebrahimnejad, M. (2020), "Numerical study of the behavior of bolted shear connectors in composite slabs with steel deck", *Structures*, **26**, 501-515. doi:<https://doi.org/10.1016/j.istruc.2020.04.037>
- Badie, S. S., Baishya, M. C. and Tadros, M. K. (1998), "NUDECK-An efficient and economical precast prestressed bridge deck system", *PCI journal*, **43**(5).
- Barker, J. M. (1975), "Research, application, and experience with precast prestressed bridge deck panels", *PCI JOURNAL*, **20**(6), 66-85.
- Bieschke, L. and Klingner, R. (1982). *The Effect of Transverse Strand Extensions on the Behavior of Precast Prestressed Panel Bridges*. Retrieved from
- Braimah, A., Green, M. F. and Soudki, K. A. (1998), "Polypropylene FRC bridge deck slabs transversely prestressed with CFRP tendons", *Journal of Composites for Construction*, **2**(4), 149-157.

- Di, J., Han, B. and Qin, F. (2020), "Investigation of U-bar joints between precast bridge decks loaded in combined bending and shear", *Structures*, **27**, 37-45. doi:<https://doi.org/10.1016/j.istruc.2020.05.041>
- Duarte, G., Carrilho Gomes, R. C., de Brito, J. d., Bravo, M. and Nobre, J. (2020), "Economic and Technical Viability of Using Shotcrete with Coarse Recycled Concrete Aggregates in Deep Tunnels", *Applied Sciences*, **10**(8), 2697.
- Fanella, D. A., Mahamid, M. and Mota, M. (2017), "Flat plate–voided concrete slab systems: design, serviceability, fire resistance, and construction", *Practice Periodical on Structural Design and Construction*, **22**(3), 04017004.
- Freyssinet. (2022a). Dammam Bridge: A strategic project in Saudi Arabia. Retrieved from http://fpcitalia.it/freyssinet/wfreyssinet_en.nsf/sb/construction.dammam-bridge
- Freyssinet. (2022b). Improvement of Al-Jamarat Bridge. Retrieved from http://www.fsa.com.sa/Project_Jamarat.html
- Fu, Q., Yan, L., Ning, T., Wang, B. and Kasal, B. (2020), "Behavior of adhesively bonded engineered wood – Wood chip concrete composite decks: Experimental and analytical studies", *Construction and Building Materials*, **247**, 118578. doi:<https://doi.org/10.1016/j.conbuildmat.2020.118578>
- Ghasemi, S., Mirmiran, A., Xiao, Y. and Mackie, K. (2016a), "Novel UHPC-CFRP waffle deck panel system for accelerated bridge construction", *Journal of Composites for Construction*, **20**(1), 04015042.
- Ghasemi, S., Zohrevand, P., Mirmiran, A., Xiao, Y. and Mackie, K. (2016b), "A super lightweight UHPC–HSS deck panel for movable bridges", *Engineering Structures*, **113**, 186-193. doi:<https://doi.org/10.1016/j.engstruct.2016.01.046>
- Goldberg, D., ASHWILL, T. D., WAD, A. A., BARKER, J. M., BARNOFF, R. M., BASSI, K. G., BEHAR-YBARRA, E., BURNS, N., COLLIER, J. and GATES, J. H. (1987), "Precast prestressed concrete bridge deck panels", *PCI J*, **32**(2), 26-45.
- Graybeal, B. A. (2006). *Material property characterization of ultra-high performance concrete*. Retrieved from
- Hájek, R., Horníková, K. and Foglar, M. (2020), "Numerical assessment of the response of a heterogeneous concrete-based composite bridge deck to a near field explosion", *Engineering Structures*, **225**, 111206. doi:<https://doi.org/10.1016/j.engstruct.2020.111206>
- Kanellopoulos, A. P. (2019). Structural Design, Earthquake Resistance and Strengthening, Transportation Projects (pp. 1-52): Cubus Engineering.
- Kumar, N. and Ramirez, J. A. (1996), "Interface horizontal shear strength in composite decks with precast concrete panels", *PCI journal*, **41**(1), 42-55.
- Kwon, K., Foreman Jr, J., Azimov, U., Klingner, R., Bayrak, O. and Jirsa, J. (2014), "Control of Cracking in Precast, Prestressed Concrete Panels for Bridge Decks", *ACI Structural Journal*, **111**(6).
- Mirmiran, A., Ghasemi, S., Mackie, K. R., Xiao, Y. and Al-Ramahee, M. (2016), "Lightweight solid decks for movable bridges - phase II".
- Moore, M., Wang, J., Albrecht, P. and Gilstrap, C. (1992). *Model bridge study. Volume V: Evaluation of precast deck panels. Final report*. Retrieved from
- Morcous, G., Jaber, F. and Volz, J. (2018). *A New Precast Concrete Deck System for Accelerated Bridge Construction*, Cham.
- Moslemi, A., Navayi Neya, B., Davoodi, M. R. and Dehestani, M. (2020), "Proposing and finite element analysis of a new composite profiled sheet deck", *Structures*, **27**, 70-85. doi:<https://doi.org/10.1016/j.istruc.2020.05.016>
- Narner, J. W. (1997), "A new generation of precast prestressed concrete slab bridges for Maryland's rural highways", *PCI journal*, **42**, 16-21.
- PCI. (1997). *Precast Prestressed Concrete Bridge Design Manual* (1st ed.).
- PCI. (2014). *Precast Prestressed Concrete Bridge Design Manual* (3rd ed.).
- Saleem, M., Mirmiran, A., Xia, J. and Mackie, K. (2010). *Alternative Deck System for Moveable Bridges*. Paper presented at the Structures Congress 2010.
- Saleem, M. A., Mirmiran, A., Xia, J. and Mackie, K. (2011), "Ultra-High-Performance Concrete Bridge Deck Reinforced with High-Strength Steel", *ACI Structural Journal*, **108**(5).
- Saleem, M. A., Mirmiran, A., Xia, J. and Mackie, K. (2015), "Experimental characterization of ultrahigh-performance concrete bridge deck system", *Journal of Bridge Engineering*, **20**(9), 04014101.
- Saleem, M. A., Zafar, M. N., Saleem, M. M. and Xia, J. (2021), "Recent Developments in the Prefabricated Bridge Deck Systems", *Case Studies in Construction Materials*, e00750. doi:<https://doi.org/10.1016/j.cscm.2021.e00750>
- Schmidt, M. and Fehling, E. (2005), "Ultra-high-performance concrete: research, development and application in Europe", *ACI Spec. Publ*, **228**(1), 51-78.
- Shahrokhinasab, E. and Garber, D. (2021), "Long-term performance of full-depth precast concrete (FDPC) deck panels", *Engineering Structures*, **244**, 112738. doi:<https://doi.org/10.1016/j.engstruct.2021.112738>
- Song, X., Huang, Y., Huang, Q. and Zheng, H. (2021), "Fatigue behavior of GFRP-concrete composite decks: An experimental and numerical study", *Structural Engineering and Mechanics*, **80**(3), 301-312.

- Su, N., Lou, L., Amirkhani, A., Amirkhani, S. N. and Xiao, F. (2021), "Assessment of effective patching material for concrete bridge deck -A review", *Construction and Building Materials*, **293**, 123520. doi:<https://doi.org/10.1016/j.conbuildmat.2021.123520>
- Tam, V. W. Y., Kotrayothar, D. and Xiao, J. (2015), "Long-term deformation behaviour of recycled aggregate concrete", *Construction and Building Materials*, **100**, 262-272. doi:<https://doi.org/10.1016/j.conbuildmat.2015.10.013>
- Tong, Z., Chen, Y., Huang, Q., Song, X., Luo, B. and Xu, X. (2020), "Experimental and analytical study on continuous GFRP-concrete decks with steel bars", *Structural Engineering and Mechanics*, **76**(6), 737-749.
- Venancio, V. G. (2016). *Behavior of ultra-high performance concrete bridge deck panels compared to conventional stay-in-place deck panels*: Missouri University of Science and Technology.
- Wu, Z. (2003), "Prestressed FRP tubular deck system".
- Xia, Y., Chen, L., Ma, H. and Su, D. (2019), "Experimental and numerical study on shear studs connecting steel girder and precast concrete deck", *Structural Engineering and Mechanics*, **71**(4), 433-444.
- Yang, Y., Sneed, L. H. and Belarbi, A. (2012), "Flexural behavior of hybrid precast prestressed bridge deck panels under static and fatigue loadings—an experimental study".
- Yuen, T. Y. P., Halder, R., Chen, W.-W., Zhou, X., Deb, T., Liu, Y., Tseng, Y. and Wen, T.-H. (2020), "DFEM of a post-tensioned precast concrete segmental bridge with unbonded external tendons subjected to prestress changes", *Structures*, **28**, 1322-1337. doi:<https://doi.org/10.1016/j.istruc.2020.09.080>
- Zafar, M. N., Saleem, M. A., Xia, J. and Saleem, M. M. (2020), "Experimental Characterization of Prefabricated Bridge Deck Panels Prepared with Prestressed and Sustainable Ultra-High Performance Concrete", *Applied Sciences*, **10**(15), 5132.